

To us, good Luminarie is a matter of
**problem solving, performance,
durability, and aesthetics**



Glowrail EVO Direct Stainless

solves two problems at once: creates bright comfortable ambient lighting and can be applied in the Modern/ Contemporary/Minimalist interior style



Minimalist design integrates into luxury kitchen



Applied in contemporary kitchen

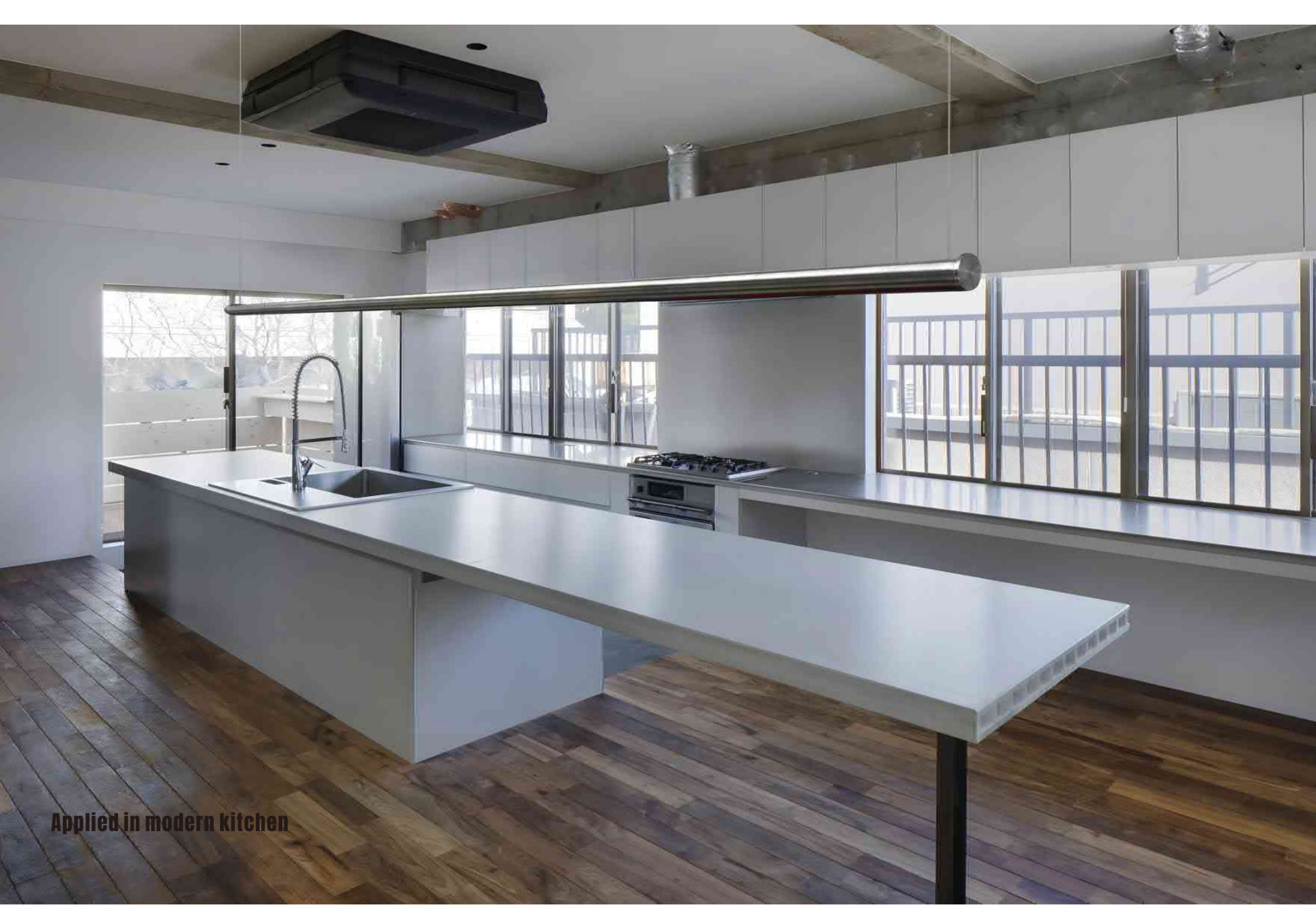

Applied in modern kitchen

Applied in minimalist interior style kitchen





Applied in contemporary kitchen







Conditions of Use

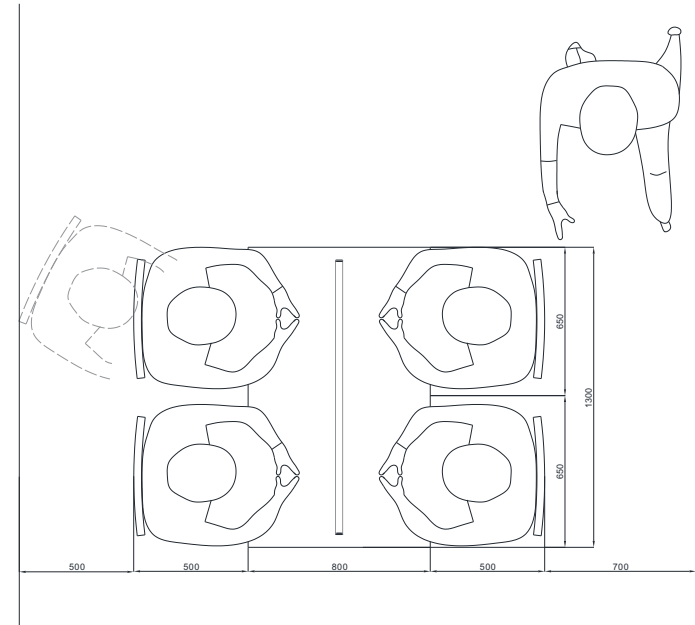
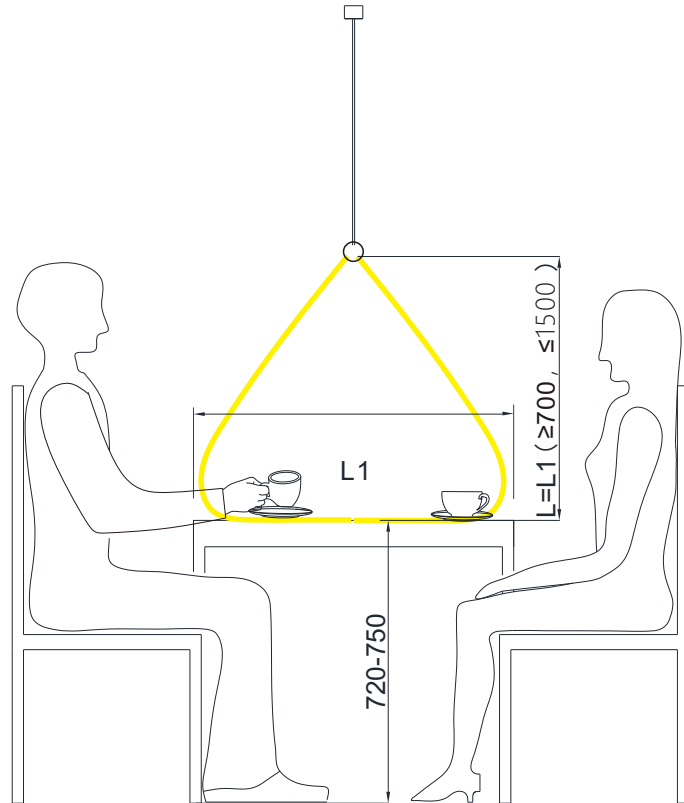

1. The reserved wire must be in the middle of the table
2. The distance between the lamp and the table is equal to the width of the table
3. The recommended length of the dining table is 1.2-1.5 meters
4. ERGONOMIC should be considered

Lighting distribution

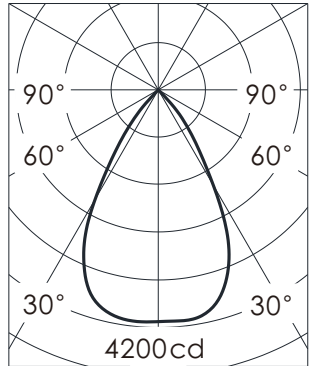

View angle : 64°

Height(m)	Illumination (lx)	Diameter (m)
1	2790	1.13
2	697.2	2.27
3	308.8	3.40
4	174	4.54
5	111	5.67

Direct luminous flux: 4560lm

Bin standard

ANSI C78.377

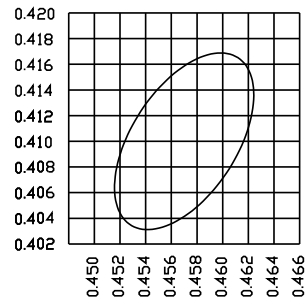

BIN-27A

Centred x	Centred y	Nominal CCT (K)	CCT Range (K)	MacAdam ellipse
0.4578	0.4101	2700	2660-2730	3SDCM

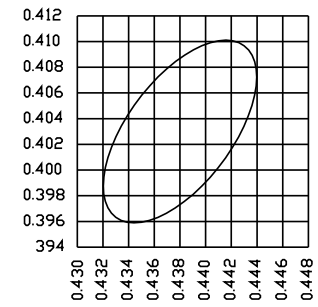

BIN-30A

Centred x	Centred y	Nominal CCT (K)	CCT Range (K)	MacAdam ellipse
0.4338	0.403	3000	2865-2940	3SDCM

Dimension

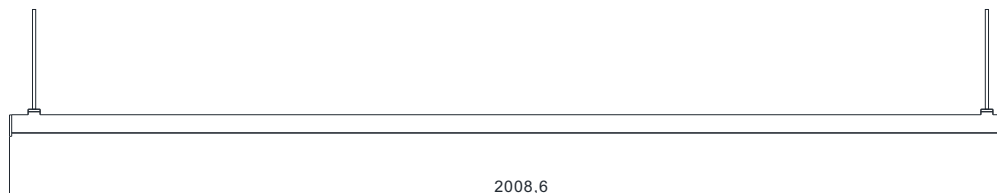
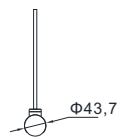

Electrical Characteristics

Voltage Range(V)	22~26
Power /pc (W)	28.5
Driver	Out
Flicker	high frequency

Optical Characteristics

Light distribution	Direct/Indirect
Luminous lux (lm)	4560
lighting source(lm/w)	150
Luminare(lm/w)	160
Color quality	2700K: CRI93 Ra95 R9 68 Rf 90 Rg 101 3000K: CRI94 Ra96 R9 72 Rf 92 Rg 101
View angle	64°
MacAdam Step	3SDCM
UGR	9
Color temperature	2700K/3000K

Physical Characteristics

Color	Stainless Steel
Composition	Stainless Steel
Case	Stainless Steel
Dimension (mm)	Φ44*2008
Net weight(kg)	5

Dependability

Warranty	5 years
Lifespan > 50.000h(Tc=85°C)	L80B50-50.000h(Tc=85°C)
IP	53
Certificate	CE RoHS
Luminare Class	III
IK	IK03
Temperature	-20 ~ +40°C

Standards&Certificates

Integrating Sphere Test	IES LM79 (lumen,CCT,CRI,XY,SDCM,wave length)
Photometric Distribution Test	IES LM79
Aging Test	IES LM84&IES TM28
Ambient Temperature Test	UL1598&UL2388&IEC60598-1&IEC60598-2-21
High temperature High Humidity Test	UL1598&UL2388&IEC60598-1&IEC60598-2-21
Bending Test	500 cycles
Vibration Test	UL2388>750cycles
Tensile Test	Defined by Manufacturer
Drop Test	UL1598&UL2388&IEC60598-1&IEC60598-2-21
IK Test	IEC62262
Fire-Rating Test	UI94
UV Test	ASTMG154,ISO4892-3,UVA@340nm IEC60529
Salt Spray Test	IEC68-2-11
Thermal Shock Test	Non-lighting -40°C-55°C (25mins) with 5mins , 100 cycles
High temperature test	55°C

Packaging



	Qty	Dimension (mm)	Net weight(kg)	Gross Weight(kg)
Inner Box	1	2100*60*60	5	5.5

Installation



Screw

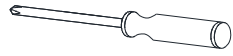

Screwdriver



Bridge



Cover



Drill



Screw nut

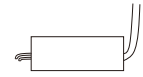

Driver



Spirit level

